

# Wildlife Damage Management Series

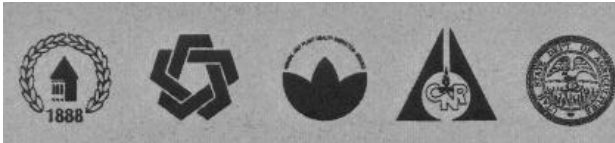

USU Extension in cooperation with:

CNR—Quinney Professorship for Wildlife Conflict Management  
Jack H. Berryman Institute  
Utah Division of Wildlife Resources  
Utah Department of Agriculture and Food  
USDA/APHIS Animal Damage Control

# Non-venomous Snakes

*Terry A. Messmer and Gerald W. Wiscomb*

Quinney Professorship for Wildlife Conflict Management  
Utah State University Extension Service and College of Natural Resources

Department of Fisheries and Wildlife  
Jack H. Berryman Institute  
Utah State University, Logan, Utah

August 1998

NR/WD/007

Snakes are probably the most feared and misunderstood animals known. There are over 200 species of snakes in the U. S., most of which (about 170) are non-venomous.

Utah is home to 31 species of snakes. Of these, 24 are non-venomous. Since these snakes are more abundant, chances are that when most Utahns encounter a snake it will be non-venomous. (See Figure 1.)

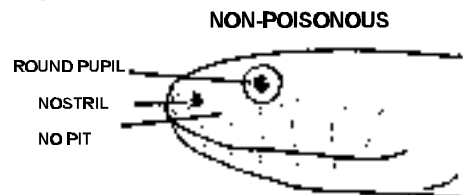
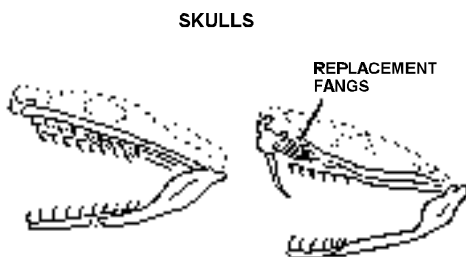
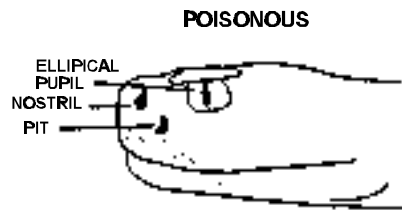
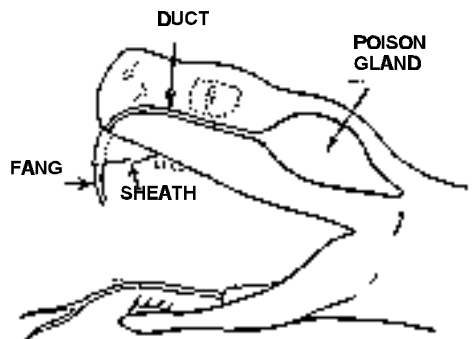

Figure 1. Poisonous snakes have vertically elliptical pupils (cat's eyes), facial pits between the nostril and eye. Non-poisonous snakes have round eye pupils and no facial pits between the nostril and eye.

The most common non-venomous snakes in Utah are the three species of garter snakes (*Thamnophis* spp.) which are commonly referred to by many as water snakes (Utah has no true water snakes), the rubber boa (*Charina bottae*), and gopher or bullsnake (*Pituophis melanoleucus*).

There are three ways to determine the difference between venomous and non-venomous snakes. As a general rule, venomous snakes have elliptical pupils and a single row of scales on the underside of their tail. Pit vipers (which are all venomous) have a pit midway between their nostrils and their eyes. Non-venomous snakes have round pupils and two rows of scales on the under side of their tail (Figure 1).

## **BIOLOGY AND BEHAVIOR**

Snakes are reptiles and are considered “cold blooded” animals which means that they maintain body temperatures approximately equal to that of their environment. When environmental temperatures drop below 50 degrees F snakes seek shelter in areas where the temperatures are maintained above freezing. Suitable shelter areas may be found under rocks or rock piles, in holes, below ground, in or under tree stumps, wood piles, debris, or many man-made structures. These locations may be used for temporary shelter or for winter hibernation. Some snakes will use the same sites as dens year after year to hibernate. Several hundred snakes may also occupy the same denning sites.

Snakes shed their skin as they grow. Several sheddings can occur throughout the year. When shedding their skin, snakes will become temporarily blinded until the old skin splits at their head and they are able to crawl out of it.

Snakes have forked tongues which contain receptors similar to taste buds. They use their tongues to sample odors in the air. Snakes can also use their tongue to “sense” their way in the dark as well as locate prey. They have hinged jaws which allow them to consume food that is larger than their body. Snakes will eat any live animal or eggs small enough to swallow. Captured prey is either eaten alive or first constricted to death before swallowing. Common prey items for non-venomous snakes includes insects, rodents, birds, eggs, and other snakes. Snakes store food as fat and can live off this fat reserve for extended periods of time.

Some snakes lay eggs (oviparous), while others give birth to live young (viviparous). Utah garter snakes, rubber boas and all rattlesnakes bear live young. Gopher snakes lay eggs, which are left to hatch on their own. Once born, young snakes are left to fend for themselves.

## **LEGAL STATUS**

Snakes are classified as non-game animals and are protected by Utah state laws. A person cannot collect or possess a live wild snake without receiving a Certificate of Registration from the Utah Division of Wildlife Resources.

## **CONTROL**

### **Identification of Damage**

Non-venomous snakes cause no direct damage to humans, structures, or pets. These snakes assist in controlling local insect and rodent populations. Some non-venomous snakes eat other snakes, even venomous ones. Occasionally snakes will enter buildings and other structures for shelter or food, which can cause the occupants to become uneasy.

Non-venomous snake bites are harmless. The only concern would be potential infection. If bitten, clean and sterilize the wound with disinfectant. Treat and cover the wound similar to any cut or abrasion you may have received previously.

If you are bitten by a venomous snake the wound will almost instantly show signs of swelling and discoloration of the surrounding tissue. A tingling sensation and nausea usually will accompany these symptoms. Bites from pit vipers (rattlesnakes) will show two prominent fang marks as well as other teeth marks.

### **Habitat**

Probably the best way of reduce problems associated with non-venomous snakes is to make the area unattractive to them. Snakes require food and shelter, if these are not present, snakes will not be attracted to the area. Keep lawns cut, weeds and other vegetation thinned, and remove wood piles, rock piles, and other debris piles. Removing these and other potential snake or rodent hiding places will also help to reduce food supplies.

### **Exclusion**

Snakes may enter buildings in search of food and shelter. The best way to exclude snakes from buildings is to close any and all possible entrances. To do this, check the foundation for cracks and openings larger than 1/4 inch, and fill these openings with caulk or concrete mortar. Metal screen or hardware cloth can also be used to close these openings. Pay special attention to areas where pipes or wires enter the building. Also, check around doors and windows for openings and repair any

openings. Consider using screens around doors and windows to reduce the chance that snakes may enter through these areas. These modifications can also help to exclude rodents and insects.

Using these exclusion methods should also be considered when building a new home. An important thing to remember when building is site location. If you build a home near permanent water sources (river, stream, lake, pond, wetlands) you will greatly increase the chances of future non-venomous snake encounters. Also, keep in mind the habitat and food requirements of snakes when landscaping.

In extreme cases, a homeowner may feel more at ease if a snake-proof fence is constructed around their property. This exclusion method is costly, yet it can be very effective at keeping all snakes out of your yard (Figures 2 and 3).

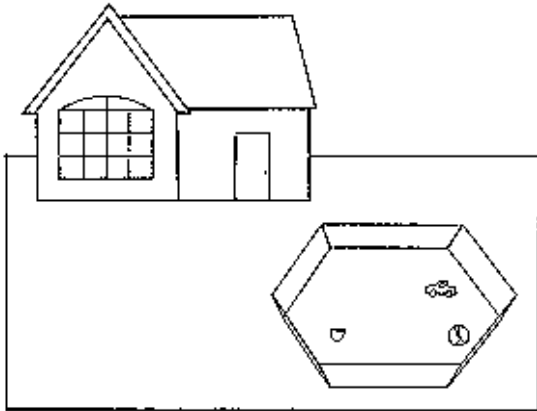

**Figure 2.** Though fairly expensive, a properly-constructed snake-proof fence can keep snakes from entering a given area.

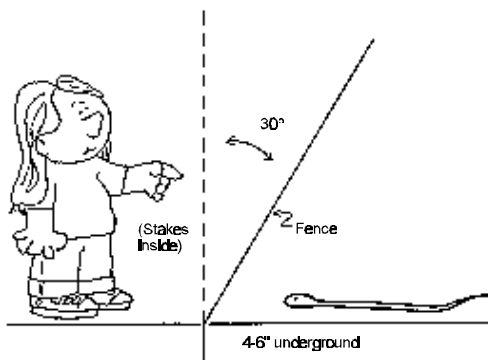

**Figure 3.** This is the side view of a snake-proof fence to exclude snakes.

## Toxicants and Repellents

There are no registered toxicants or repellents used for snake control.

## Trapping and Removal

If snakes continue to frequent an area, even though you have modified the habitat, it may be necessary to trap and remove them. Remember that snakes are protected in Utah and they should not be killed without proper cause.

The best way to remove snakes from buildings is to use long capture tongs or other long suitable item (pole, stick, etc.) then place them into a container for removal. It is not recommended you capture snakes by hand.

A pile of damp burlap bags can also be used to attract snakes and assist in removing them from enclosed areas. Place the pile of bag in a dark cool place, cover with a dry bag to help keep the others damp. This will serve to concentrate the snakes as they will be attracted to this area to escape the heat of the day. Remove the bags and snake(s) with a large flat shovel in the middle of the day when the snakes are more likely to be inside.

Glue boards may also be used to capture and remove snakes (Figure 4). Attach three or four rat-size glue boards to a piece of plywood (16x24 inches) or staple them together. Place the glue boards along an inside wall or along the foundation. Snakes generally move along walls. When a snake moves over the glue board it will become attached to the board. Once the snake is attached, the glue board can be removed. To

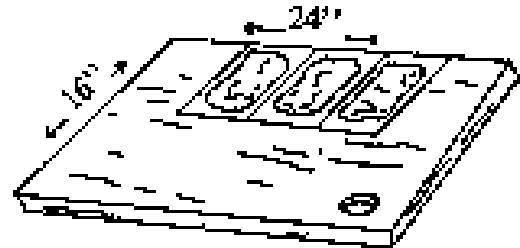

**Figure 4.** A glue trap to catch snakes indoors or under porches can be made by attaching rodent glue traps to a wooden board.

avoid close contact with an agitated snake, or if you are a little squeamish about getting too close to snakes, consider fastening a wood extension handle to the glue board plywood base before placing the trap.

To release a snake caught in a glue board, take it to a suitable area, place the glue board flat on the ground, and pour vegetable oil on the snake. The vegetable oil will reduce the tackiness of the glue and allow the snake

to free itself.

Traps can also be used to capture snakes. The best trapping method used is the funnel trap and drift fence method (Figure 5). A funnel trap can be constructed from a 3 x 4 foot 1/4 inch piece of mesh hardware cloth. Roll the hardware cloth into a cylinder about a foot in diameter and 4 feet long. Construct an entrance funnel of the same type hardware cloth and fasten it to one end and cover the other end with another piece of hardware cloth, attach it so it can easily be opened to let the snake out once it is relocated. Attach the drift fence constructed of 1/4 inches hardware cloth, about 2 feet high and 25 feet long. Post for the fence should be placed on the back side. The drift fence is used to help guide the snakes into the trap. To catch snakes coming from both directions it may be best to place another funnel trap and drift fence facing the other direction. Captured snakes should be released in alternative areas containing plenty of cover and far enough away from other buildings so the potential for other encounters will be minimized.

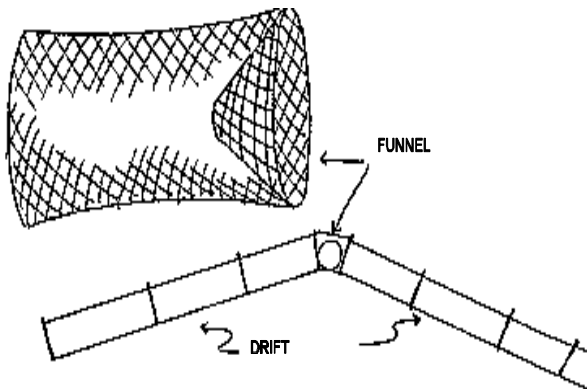

**Figure 5. A funnel trap with a drift fence is one way to catch snakes.**

## **FOR FURTHER INFORMATION, CONTACT**

USDA/ APHIS Wildlife Services  
P.O. Box 26976  
Salt Lake City, UT 84126  
(Phone 801-975-3307)

Quinney Professor for Wildlife Conflict Management  
Fisheries and Wildlife Extension Specialist  
Department of Fisheries and Wildlife  
Utah State University, Logan, UT 84322-5210  
(Phone 435-797-3975; 435-797-8876)

Utah Division of Wildlife Resources  
1594 West North Temple  
Salt Lake City, UT 84116-3154  
(Phone 801-538-4700)

### **Additional Readings**

Burt, W. H. and R. P. Grossenheider. 1985. The Peterson Field Guide Series. A Field Western Reptiles and Amphibians. Second Edition. Houghton Mifflin Company. Boston.

Byford, J. L. 1983. Non-poisonous snakes. in Prevention and Control of Wildlife Damage. Great Plains Agricultural Council Wildlife Resources Committee. University of Nebraska-Lincoln Cooperative Extension Service. Lincoln, NE.

Cleary, E. And T. A. Messmer. 1986. Snakes. NDSU Extension Service. North Dakota State University. Fargo, ND.

Henderson, F. R. And L. Charles. 1992. Snakes: Urban Wildlife Damage Control. Kansas State University Cooperative Extension Service. Manhattan, KS.

Utah State University Extension is an affirmative action/equal employment opportunity employer and educational organization. We offer our programs to persons regardless of race, color, national origin, sex, religion, age or disability. Issued in furtherance of Cooperative Extension work, Acts of May 8 and June 30, 1914, in cooperation with the U.S. Department of Agriculture, Robert L. Gilliland, Vice-President and Director, Cooperative Extension Service, Utah State University, Logan, Utah.(EP/01-99/DF)